

Shelfspan

making better use of space

SHELVING ASSEMBLY INSTRUCTIONS
 ISTRUZIONI DI MONTAGGIO SCAFFALATURA
 NOTICE D'INSTRUCTION RAYONNAGE
 REGALE BEDIENUNGSANLEITUNG
 MANUAL DE ISTRUCCIONES ESTANTERIA

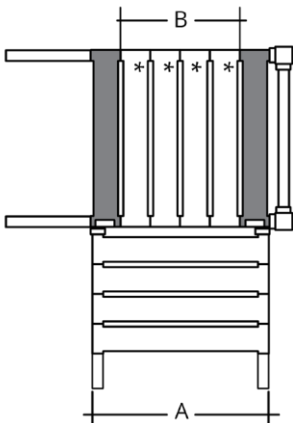
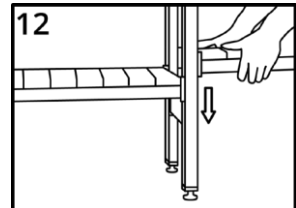
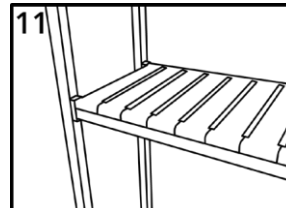
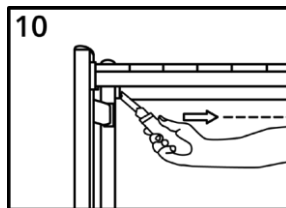
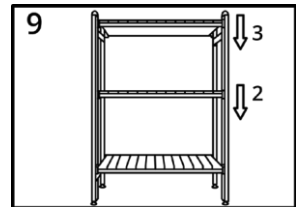
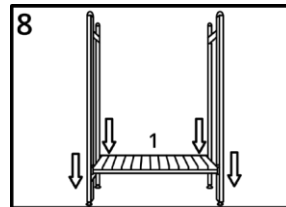
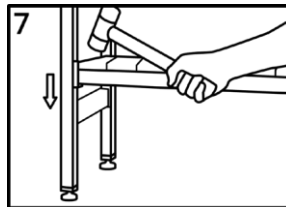
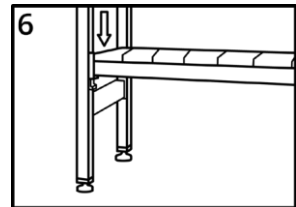
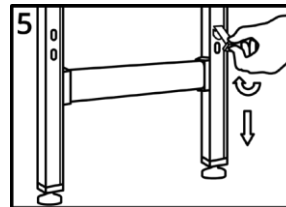
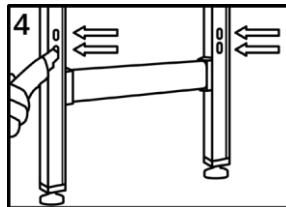
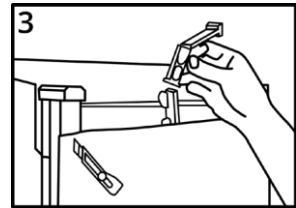
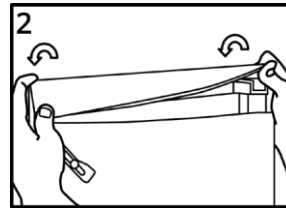
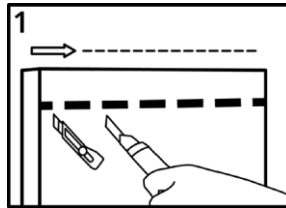
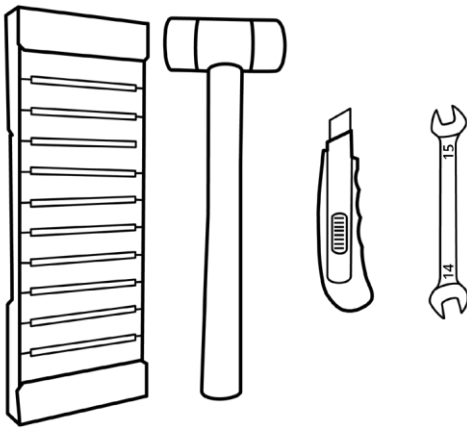
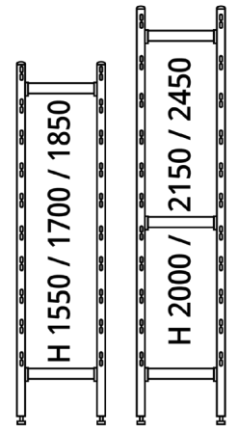
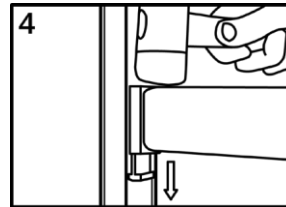
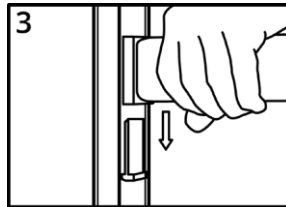
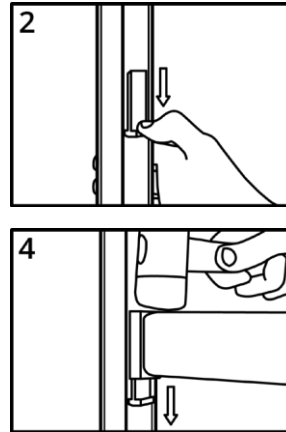
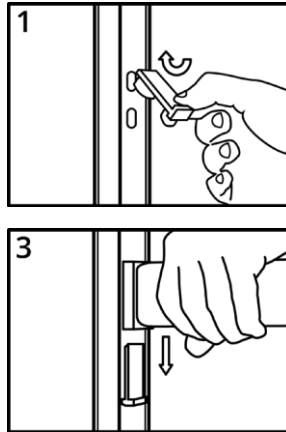
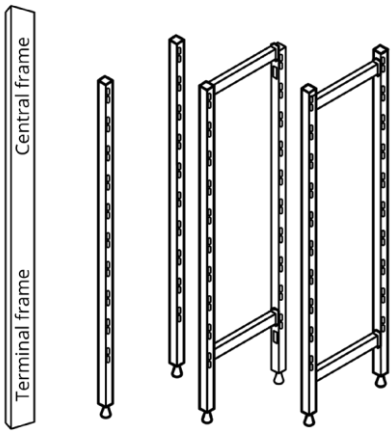

A mm	B *
300	2
375	3
450	4
525	5
600	6

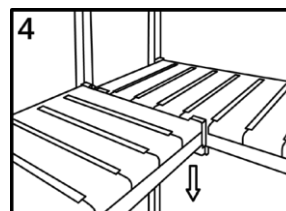
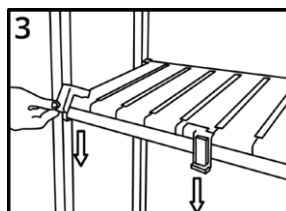
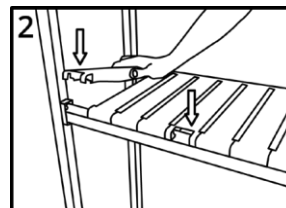
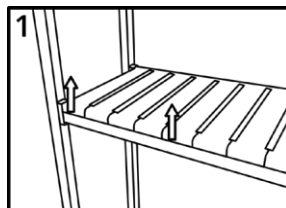

VIDEO



Shelfspan

making better use of space

Head Office: Cart Lodge, Mayland Hall Farm, Mayland Hill,
 Althorne, Essex CM3 6EA